

30DSERIES

turbofan[®]

E35D6

Convection Oven

Installation and Operation Manual

turbofan
CONVECTION OVEN SYSTEMS

MOFFAT

BLUE SEAL

MANUFACTURED BY

Moffat Limited
Rolleston 7675
New Zealand

INTERNATIONAL CONTACTS

AUSTRALIA

Moffat Pty Limited

E.Mail: vsales@moffat.com.au
Main Office: (tel): +61 (03) 9518 3888
(fax): +61 (03) 9518 3833
Service: (tel): 1800 622 216
Spares: (tel): 1800 337 963
Customer Service: (tel): 1800 335 315
(fax): 1800 350 281

CANADA

Serve Canada

Web: www.servecanada.com
E.Mail: info@servecanada.com
Sales: (tel): 800 551 8795 (Toll Free)
Service: (tel): 800 263 1455 (Toll Free)

NEW ZEALAND

Moffat Limited

Web: www.moffat.co.nz
E.Mail: sales@moffat.co.nz
Main Office: (tel): 0800 663328

UNITED KINGDOM

Blue Seal

Web: www.blue-seal.co.uk
E.Mail: sales@blue-seal.co.uk
Sales: (tel): +44 121 327 5575
(fax): +44 121 327 9711
Spares: (tel): +44 121 322 6640
(fax): +44 121 327 9201
Service: (tel): +44 121 322 6644
(fax): +44 121 327 6257

UNITED STATES

Moffat

Web: www.moffat.com
Sales: (tel): 1-800 551 8795 (Toll Free)
(tel): 336 661 1556
(fax): 336 661 9546
Service: (tel): 866 673 7937 (Toll Free)

REST OF WORLD

Moffat Limited

Web: www.moffat.co.nz
E.Mail: export@moffat.co.nz

The reproduction or copying of any part of this manual by any means whatsoever is strictly forbidden unless authorized previously in writing by the manufacturer.

In line with policy to continually develop and improve its products, Moffat Ltd. reserves the right to change the specifications and design without prior notice.

© Copyright Moffat Ltd. March 2017.

Contents List

E35D6 Turbofan Convection Oven.

Introduction	2
Safety Information	
Specifications	3
Installation	6
Installation Requirements	
Unpacking	
Location	
Clearances	
Stand Mounted Ovens	
Electrical Connection	
Water Connection	
Recommended Water Specifications	
Positioning and Levelling of Oven	
Initial Start-Up	
Commissioning	
Operation	8
Operation Guide	
Baking in Manual Mode	
Cooking in Manual Mode using Core Temp Probe	
Baking in Program Mode	
Programming	15
USB Export / Import	18
Programs	
Parameters	
Programs Revision Numbering	
Files	
Controller - Operator Settings	22
Changing Operator Settings	
Operator Settings	
Cleaning and Maintenance	23
Cleaning Guidelines	
Oven Cleaning	
Periodic Maintenance	
Fault Finding	25
Electrical Schematics	26
Replacement Parts List	29
Appendix 1 - Reversing the Oven Door	31
- Oven Door Adjustment	32

Introduction

Before using your new oven, please read this instruction manual carefully, pay particular attention to any information labelled **'WARNING'**, **'CAUTION'**, **'IMPORTANT'** or **'NOTE'** in this manual.



Warning

Indicates a hazardous situation which, if not avoided, will result in death or serious injury.



Caution

Indicates a hazardous situation which, if not avoided, will result in minor or moderate injury.

If you are unsure of any aspect of the installation, instructions or performance of your oven, contact your TURBOFAN dealer promptly. In many cases a phone call could answer your question.

Should you contact your TURBOFAN dealer on any matter concerning this oven, please have the information provided opposite, readily available.

This manual must be kept by the owner for future reference.

A record of **Date of Purchase**, **Date of Installation** and **Serial Number of the oven** should be recorded in the area provided below.

The serial number of this oven can be found on the Technical Data Plate located on the front right hand side panel, see diagram in 'Installation Section'.

Model Number:

Serial Number:

Dealer:

Service Provider:

Date Purchased:

Date Installed:

Safety Information

For your safety, please pay attention to the following symbols marked on the appliance.

- Risk of electric shock.



No user serviceable parts inside.
Qualified service person access only.
Disconnect from power before servicing.

Specifications

E35D6 - Oven Power Ratings

USA / Canada / Mexico					
Model	Voltage	Frequency	Phase	Amps	Electrical Rating
E35D6-**-T263	220-240V	60 Hz	3P+E	30.3	12.5kW @ 240V
E35D6-**-P263	208V	60 Hz	3P+E	31.1	11.2kW @ 208V
E35D6-**-T261	220-240V	60 Hz	1P+N+E	52.0	12.5 kW @ 240V
E35D6-**-P261	208V	60 Hz	1P+N+E	53.7	11.2 kW @ 208V
Australia / New Zealand / UK					
Model	Voltage	Frequency	Phase	Amps	Electrical Rating
E35D6-**-453	400-415V	50 Hz	3P+N+E	17.4	12.5kW @ 415V
E358D6-**-453	400-415V	50 Hz	3P+N+E	11.1	8.0kW @ 415V
E35D6H-**-453	400-415V	50 Hz	3P+N+E	18.3 / 17.4 / 17.4	12.7kW @ 415V
E35D6-**-251	230-240V	50 Hz	1P+N+E	52.0	12.5 kW @ 240V
E35D6H-**-251	230-240V	50 Hz	1P+N+E	52.9	12.7 kW @ 240V
International					
Model	Voltage	Frequency	Phase	Amps	Electrical Rating
E35D6-**-353	380V	50 Hz	3P+N+E	18.9	12.5kW @ 380V
E35D6-**-363	380V	60 Hz	3P+N+E	18.9	12.5kW @ 380V
E35D6-**-P263	208-220V	60 Hz	3P+E	32.8	12.5kW @ 220V
E35D6-**-T263	230-240V	60 Hz	3P+E	30.1	12.5kW @ 240V
E35D6-**-P253	208-220V	50 Hz	3P+E	32.8	12.5kW @ 220V
E35D6-**-T253	230-240V	50 Hz	3P+E	32.8	12.5kW @ 240V

Specifications

E35D6-26 - Turbofan Convection Oven

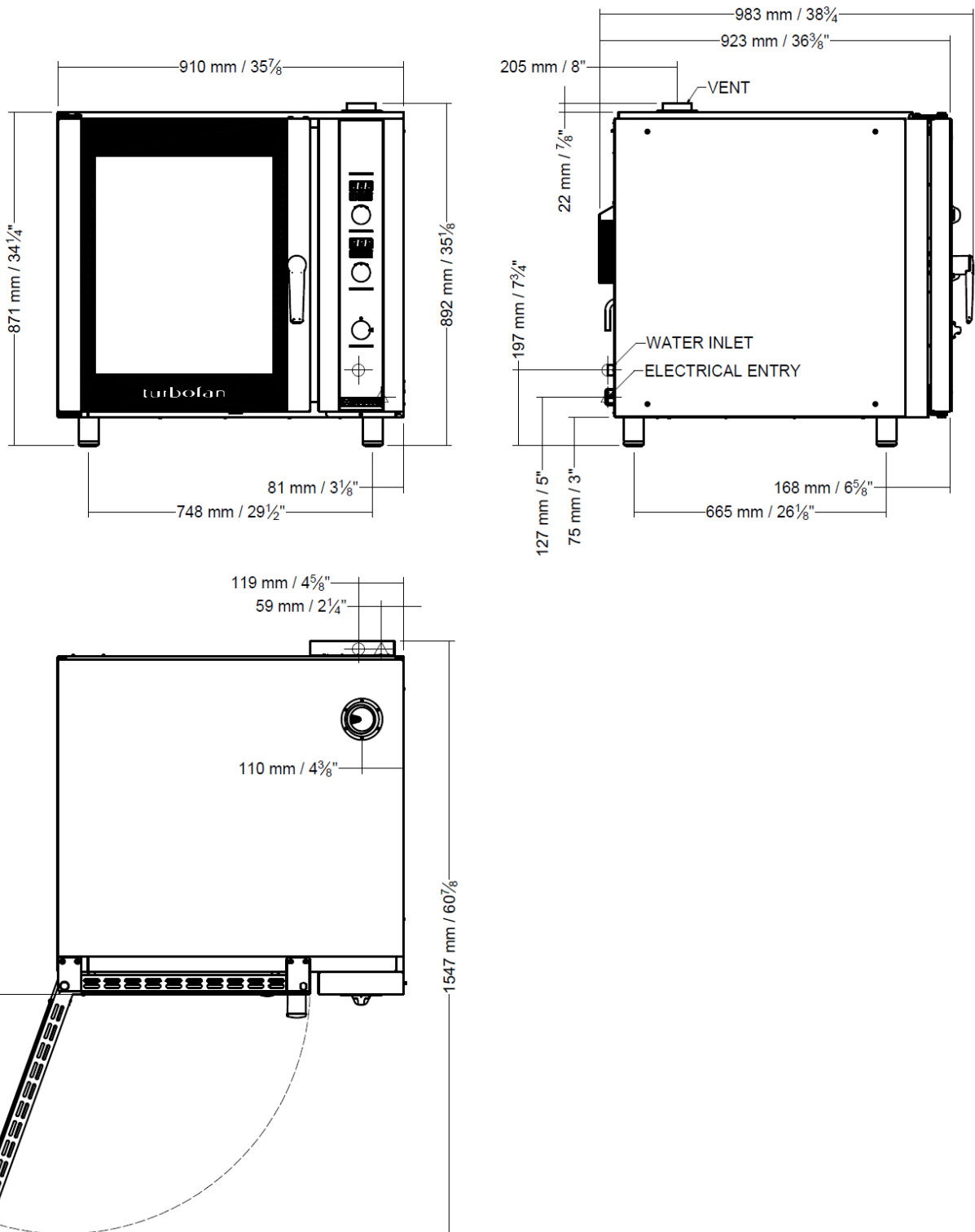

Oven Tray Details	Tray Capacity	Qty 6, 460 x 660mm / 18" x 26", Full Size Sheet Pan Capacity.
	Tray Spacing	105mm / 4 1/8".
Water Connection	Max Water Inlet Pressure	80 psi / 550 kPa.
	Connection Size	3/4" BSP Male.
NOTE: If the bake Steam / Moisture Mode baking option is not required, the oven does not need to be connected to a water supply.		

Specifications

E35D6-30 - Turbofan Convection Oven

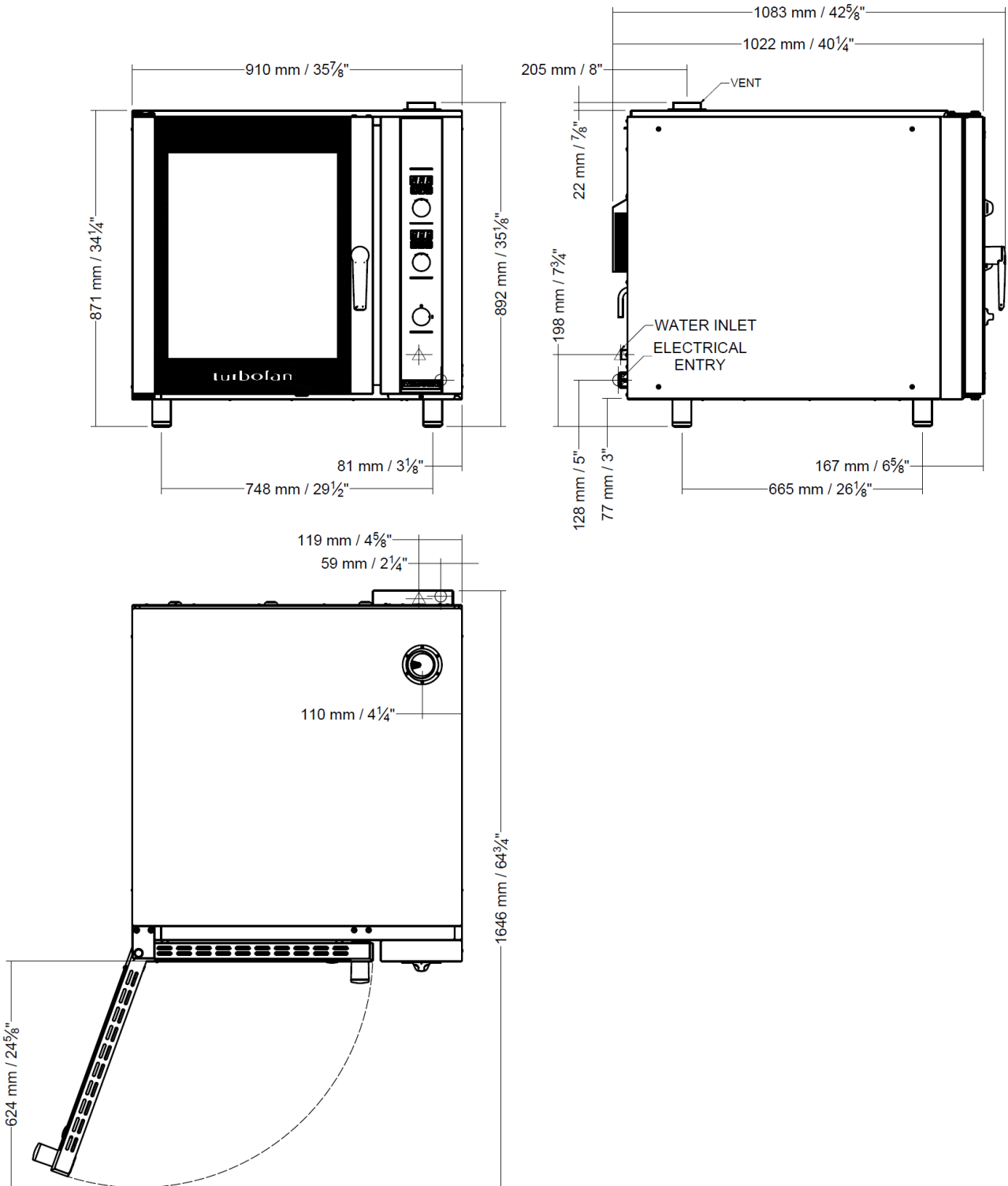

Oven Tray Details	Tray Capacity	Qty 6, 460 x 762mm / 18" x 30", Tray Capacity.
	Tray Spacing	105mm / 4 ¹ / ₈ ".
Water Connection	Max Water Inlet Pressure	80 psi / 550 kPa.
	Connection Size	³ / ₄ " BSP Male.
NOTE: If the bake Steam / Moisture Mode baking option is not required, the oven does not need to be connected to a water supply.		

Installation

Installation Requirements

Important:

- Installation shall comply with local electrical, health and safety requirements.
- It is most important that this oven is installed correctly and that oven operation is correct before use.
- If you have any questions regarding the proper installation and / or operation of this oven, please contact your local Turbofan distributor.

Unpacking

1. Remove all packaging and transit protection including all protective plastic coating from the exterior stainless steel panels.
 2. Check the oven and supplied parts for damage. Report any damage immediately to the carrier and distributor.
 3. Check that the following parts have been supplied with your oven:-
 - 4 x Leg Adjustable.
 - Brass Adaptor. } **USA / Canada / Mexico Only.**
 - Rubber Washer. }
 4. Report any deficiencies to the distributor who supplied your oven.
 5. Securely fit the 4 legs supplied with the oven.
 6. Check that the available electrical supply is correct to that shown on the Technical Data Plate located on the front right hand side panel.
- Also refer to the 'Specifications' section, 'Oven Specifications Tables' for further details.



Technical Data Plate Location

Clearances

To ensure correct ventilation for the motor and controls, the following minimum installation clearances are to be adhered to:-

Rear	50mm / 2"
Left-hand side	50mm / 2"
Right-hand side	50mm / 2"

CLEARANCE FROM SOURCE OF HEAT.
A minimum distance of 300mm (12") from appliance sides is required.

NOTE: Fixed installations require at least 500mm - 20" clearance at the right hand side of oven for service access.

Important:

The vent located on the top of the oven must NOT be obstructed.



Stand Mounted Ovens

For stand mounted ovens, the oven feet are used to level the oven on the stand. Refer to the instructions supplied with separately ordered stands for mounting details.

Location

1. Position the oven in its approximate working position.
2. The unit should be positioned so that the control panel and oven shelves are easily reachable for loading and unloading.

NOTE: The oven door can be reversed to increase accessibility in certain locations. Refer to Appendix 1 at the rear of this Manual for door reversal details.

Installation

Side Racks

1. The side racks can be fitted in one of two positions, in order to take 16 or 18 inch trays.
2. To position racks for 16 inch trays, use the holes at the rear of the rack.
3. Alternatively for 18 inch trays, use the holes nearest the centre of the oven.

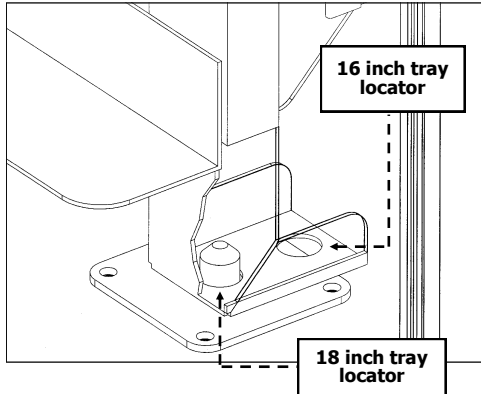

Electrical Connection



Warning

This oven must be earthed / grounded.

RCD (Residual Current Device) / GFCI (Ground-Fault Circuit-Interrupter) protection of the power supply to this appliance is recommended.

Each oven should be connected to an adequately protected power supply with an appropriate power cord.

An isolation switch must be mounted adjacent to, but not behind the oven and must be readily accessible to the operator. This switch must be clearly marked and readily accessible in case of fire.

Check the electricity supply is correct to as shown on the Technical Data Plate on the front right hand corner of the oven side panel.

NOTE: All electrical connections must only be carried out by a suitably qualified person.

1. Remove oven right hand side panel.
2. Bring the supply cable up through the cable entry point - compression gland at the back of oven.
3. Connect the supply cable to the appropriately marked terminals on the terminal block.

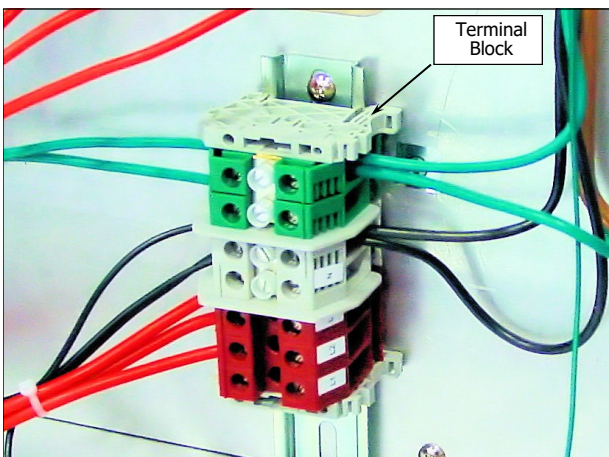

Water Connection

NOTE: Water connection shall be installed in accordance with local water regulations in force and the applicable standard / code, e.g.: PCA in Australia, EN 1717 in UK / IE.

NOTE: If the Bake Steam / Moisture Mode is not required, the oven does not require connecting to a water supply.

1. Connect a cold water supply to the water inlet (R 3/4" Connector) on the oven.

NOTE: For North America / Canada / Mexico, use supplied 3/4" GHT Brass Adaptor when making water connection to the oven.

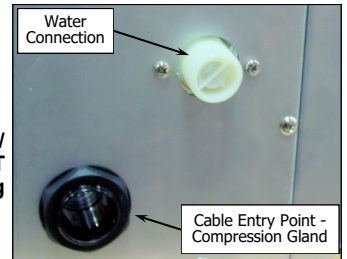

- Max Inlet Pressure 80psi / 550kPa.

2. Turn 'On' the water supply and check for leaks.

Recommended Water Specifications

In order to prevent corrosion or scaling in the oven and water system due to supplying water that is either too soft or too hard, the following recommendations should be used as a guideline.

Hardness: Between 60 and 90ppm.
PH: Greater than 7.5.
Chlorides: Less than 30 ppm.

Positioning and Levelling of Oven

1. Correctly locate the oven into its final operating position and, using a spirit level, adjust the oven feet so that the oven is level and at the correct height.

Initial Start-Up

Before using the new oven;

1. For first time use of the oven, operate the oven for about 1 hour at 200°C / 400°F to remove any fumes or odours which may be present.
2. Please refer to the Operation Section of this manual for details on how to correctly operate and shutdown the oven.

Commissioning

Before leaving the new installation;

1. Check the oven functions in accordance with the operating instructions specified in the 'Operation' section of this manual.
2. Ensure that the operator has been instructed in the areas of correct operation and shutdown procedure for the appliance.

NOTE: If it is not possible to get the appliance to operate correctly, turn 'Off' power supply at the mains supply and contact the supplier of this appliance.

Operation

Operation Guide



Warning

Some parts of this oven will become **VERY HOT** during use and could cause burns if touched.



Warning

Take care when opening the oven door during baking. Let the hot air and steam escape before removing or replacing food as the steam produced can cause steam burns.

- This oven is intended for use in a commercial kitchen and must only be put to the use for which it was designed, i.e. baking food



Temperature Display -

Shows pre-set chamber temperature. When used with the 'Temp' key, display shows actual oven temperature for 5 seconds. Shows baking programs and error codes.



'Steam' Key and LED -

Used to set / initiate steam injection time (Bake Steam Mode). LED is 'On' when steam is injecting.

Used to set automatic moisture level (Moisture Mode). LED is 'On' when automatic moisture injection is set.

Temperature Adjustment Control



Time Display - e.g. 1.25 minutes.

Shows cook time in full minutes only from 180 - 10, and in minutes and seconds for the final 10 minutes.

NOTE:

In Core Temp Mode, time display alternates between 'CP' and set core probe temperature.



'Vent' Key and LED -

Opens or closes the oven vent. LED is 'Flashing' when vent is open.

LED is 'Off' when vent is closed.

Time Adjustment Control

NOTE: In Core Temp Mode, 'Timer' knob is used to set core probe temperature.

'On / Off' (Stand-by) Control



'Program' Key and LED -

Used to enter/exit Manual and Program Modes. Used to select baking programs, and to set baking parameters.



'Temp' Key and LED -

Displays actual oven temperature for 5 seconds on Temperature Display. LED is 'On' when heating element is on (heating indicator).

LED flashes when Upper Display is showing actual temperature.

NOTE:

In Core Temp Mode, this key is used to display Actual Oven Temperature (Upper Display) and actual Core Probe Temperature (Lower Display).



'Stand-By Indicator LED -

LED is 'On' when mains power is supplied to the oven, but 'On/Off' switch is 'Off'.



'Fan Lo' Speed Key and LED -

Switches oven fan from high to low speed. LED is 'On' when fan is in Low Speed Mode.

When LED is 'Off', fan is in High Speed Mode.



'Timer-Start/Stop' Key & LED -

The 'Timer-Start/Stop' key is used to control the following functions:-

- Starting Timer / Program.
- Cancelling and Re-Setting Timer / Program.
- Cancelling Alarm (All Modes).
- Starting Core Temp Mode (Core Temp Mode).

Core Probe Connection Point.

Operation

Manual Mode

In Manual mode the ovens settings are.

- Temperature - 60-260C / 140-500F.
- Timer setting - 0-180min or Infinite.
- Fan Speed setting - Hi / Lo.
- Steam setting - 0 - 9 Seconds.
- Vent - Open / Closed.

An Optional Core Probe can also be used in Manual Mode.

Program Mode

In Program Mode 30 Programs are able to be used.

In each program the following settings are possible.

- Temperature - 60-260C / 140-500F.
- Time - 0-180min or Infinite.
- Fan Speed - Hi/ Lo.
- Steam - 0 - 9 Seconds.
- Vent - Open / Closed.

3 baking stages can also be set in each of the 30 programs.

- All settings can be changed between baking stages.
- At completion of each stage an end of stage alarm can also be set.

Optional Core Probe can also be used in Program Mode.

Changing between Manual and Program Modes



Press 'Program' key to select Program Mode. The LED will illuminate showing Program Mode now set. Press 'Program' Key to return to Manual mode.

Fan Speed

This oven features a 2 speed fan.

- Hi Speed - This is the default operating speed.
 - Hi Fan should be used for most applications.
 - Hi Fan provides the fastest cooking time and evenness throughout oven.
- Lo Speed - This is the optional setting.
 - Lo Fan speed is selected using the Fan Lo key.
 - Lo Fan should be used on delicate products such as cake and muffin.

On start-up, the oven will always default to normal Hi speed fan.

Fan speed can be changed at any time during use.

In Program Mode, fan speed can be pre-set and each baking stage can have a different fan speed.

Changing the Fan Speed



Press 'FAN LO' key to change to Lo Fan speed. LED will illuminate showing Lo Fan speed is now set. Press 'FAN LO' key to change back to Hi Speed fan.

Vent

This oven features an automatic oven vent. On Start-Up, the oven will always default to 'Vent Open'.

The vent position can be changed at any time during use.

In Program Mode, the vent position can be pre-set and each stage can have a different vent position.

Changing the Vent Position



Press 'VENT' key to open vent. LED will flash whilst vent is moving and will illuminate when vent is open. Press 'VENT' key again to close the vent.

Steam

Steam can be injected into the oven for a pre-determined length of time (from 1 sec to 9 secs).

Steam can be injected at any time during use.

In Program Mode, the steam time can be set to automatically activate at the beginning of a stage for between 0 to 9 seconds.

Changing Steam Time (Manual Mode)



Press and hold the 'Steam' key until the 'Stx' time is displayed and flashing in the upper display.

Rotate the 'Temp' knob +/- to select the steam time required (0 - 9 seconds).

Press 'Steam' key again to confirm the setting.

Moisture Mode - Optional Setting

(Refer 'Controller-Operator Settings' - 'Est = 2')

Optionally, the oven can be set to operate at one of six levels of pre-set moisture injection. (H-0 - H-5).

- When Moisture Mode H-0 is selected, a shot of steam is available whenever the oven is running, by pressing the 'Steam' key.
- When Moisture Mode H-1 (Minimum) to H-5 (Maximum) are selected, these moisture modes will only operate when a program is running, Core Temp Probe Mode has been selected or when a timer is running in Manual Mode.

Selecting Moisture Mode



Press 'Steam' key to activate Moisture Mode. 'Steam' key LED will illuminate when Moisture Mode is 'On'. Moisture Mode will operate at the preset level during the cooking cycle.

Changing Moisture Mode Level



Press and hold the 'Steam' Key until the 'H-X' level is displayed and flashing in the upper display. Rotate the 'Temp' Knob -/+ to select Moisture Mode level required. Press the **STEAM** Key to confirm setting.

The 'Moisture' Mode level can be changed at anytime during operation by following the setting method as described above.

- When setting Moisture level, consider the Oven Set Temperature. If set BELOW 100°C (212°F), water may pool in oven as temperature will be too low to create steam.

Core Temp Cooking Mode - Optional

An Optional Core Temp Probe Kit #236060 is available for this oven.

This allows use of the Core Probe Cooking feature of this oven. When the core probe is fitted to the connection point on control panel side, the timer function and display becomes the core temp probe temperature setting and display. Cooking completion is then determined by the core temp probe reaching the set core probe temperature.

To enable Core Probe Cooking Mode plug in the Core Probe. The Timer Display will then change to 'CP' (Core Probe). The Timer Knob function will then be for Core Temp setting. To disable Core Probe Cooking Mode, unplug the Core Probe. The Timer Display and Knob will return to time function.

Operation

Baking in Manual Mode

On oven start-up the controller defaults to the following settings:-

Oven Temperature is set to 150°C (325°F). Refer 'Controller - Operator Settings' section to change this start-up temperature.

Oven Timer is not set, display shows '---'.

Steam time is set to the previous setting used in Manual Mode.

Fan Speed is set to Hi Speed.

Vent is closed.

1. SET OVEN TEMPERATURE.



Rotate 'Temp' knob to select temperature required.
+ to increase the temperature (Max. 260°C / 500°F).
- to decrease the temperature (Min. 60°C / 140°F).

The oven will commence heating to the displayed set temperature.

NOTE: The oven can be used without using the timer.

2. SET TIMER.



Rotate 'Timer' knob to select time required.
+ to increase the time (Max. 180 minutes).
- to decrease the time (Min. 1 minute).

NOTE: Timer can be set to 'Infinity' **Inf**. If timer is set to 'Infinity', timer will count elapsed time to a max of 999 minutes and elapsed time will be shown on the Lower Display.

3. SET STEAM TIME.



Press and hold 'Steam' key for 3 seconds.
Rotate 'Temp' knob to select desired steam time (**St0** to **St9**).
Press 'Steam' key to confirm settings.

4. SET FAN SPEED.



Press 'Fan Lo' key, to change fan speed. 'Fan Lo' LED will illuminate when fan low speed is selected.

5. SET VENT 'OPEN' / 'CLOSED'.



Press 'VENT' key to open / close vent.
LED will flash whilst vent is open. LED unlit when vent is closed.

6. STARTING TIMER.



Press 'Timer-Start/Stop' key to start timer operation. LED will illuminate to indicate the timer is running.
Opening oven door when timer is operating will pause timer and turn 'Off' fan and heating. Timer LED will flash.
Press and hold 'Timer-Start / Stop' key for 3 seconds to cancel timer.

7. INITIATING STEAM INJECTION



Press 'Steam' key to initiate timed injection of steam into the oven.
'Steam' LED will illuminate whilst steam is being injected.

8. CANCELLING 'TIME UP' ALARM (BAKING TIME COMPLETED).



When the set Baking Time is completed, alarm will sound and Lower Display flashes. Fan and heating are paused.

- Press 'Timer-Start/Stop' key to cancel alarm, oven will continue baking at Oven Set Temperature. Displays will revert to Set Temperature and Time.
- Alternatively, open oven door to cancel alarm. Close oven door to resume baking at Oven Set Temperature. Display will revert to Set Temperature and Time.

NOTE: Any of the above settings can be adjusted during the baking operation by using the above controls and keys.



- **Viewing Actual Oven Temperature.** Press 'Temp' key during baking, oven Actual Temperature will display on Upper Display for 5 seconds and then revert to displaying Oven Set Temperature.

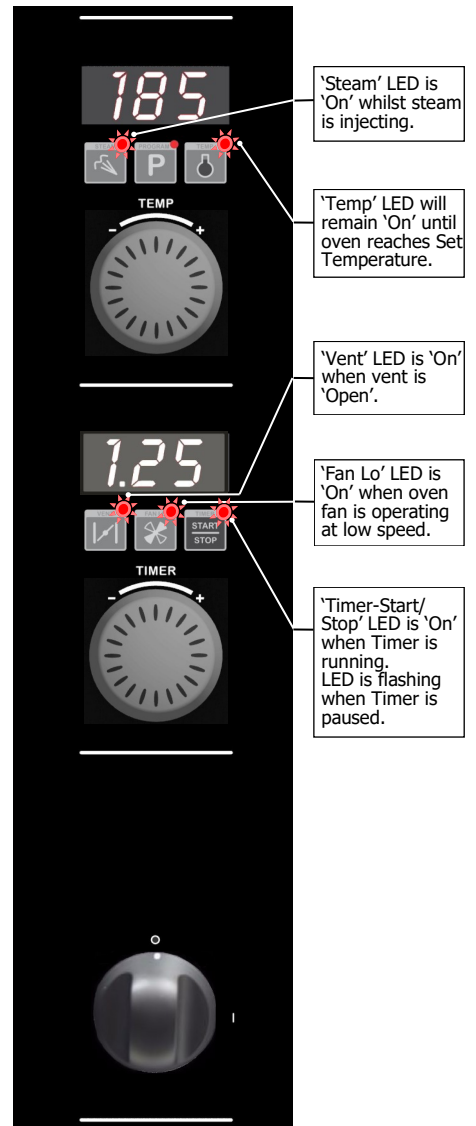

Operation

Cooking in Manual Mode using Core Temp Probe (Requires Optional Core Temp Probe Kit #236060).

On oven start-up the controller defaults to the following settings:-

Oven Temperature is set to 150°C (325°F). Refer 'Controller - Operator Settings' section to change this start-up temperature.

Oven Timer is not set, display shows '---'.

Steam time is set to the previous setting used in Manual Mode.

Fan Speed is set to Hi Speed.

Vent is closed.

1. CONNECT CORE TEMP PROBE.

Connect Core Temp Probe to connector on lower right side of control panel,



'CP' will be displayed on Lower Display.

2. SET OVEN TEMPERATURE.



Rotate 'Temp' knob to select temperature required.

+ to increase the temperature (Max. 260°C / 500°F).

- to decrease the temperature (Min. 60°C / 140°F).

The oven will commence heating to the displayed set temperature.

3. SET CORE PROBE TEMPERATURE.



Rotate Timer Knob to set the desired core probe temperature.

+ to increase temperature (Max. 90°C / 194°F).

- to decrease temperature (Min. 50°C / 122°F).

Once Core Probe Set Temperature is set, Lower Display will alternately flash between 'CP' and Core Probe Set Temperature.

'Timer-Start/Stop' LED is 'Off', indicating that cooking has not yet started.

4. SET STEAM MODE OR MOISTURE MODE.



Press and hold 'Steam' key for 3 seconds.

Rotate 'Temp' knob to select desired steam / moisture level.

Press 'Steam' key to confirm settings.

NOTE: Refer to 'Steam / Moisture Mode Settings' at start of this section for additional explanation of moisture level adjustments.

5. SET VENT 'OPEN' / 'CLOSED'.



Press 'VENT' key to open / close vent.

LED will flash whilst vent is open. LED unlit when vent is closed.

6. SET FAN SPEED.



Press 'Fan Lo' key, to change fan speed. 'Fan Lo' LED will illuminate when fan low speed is selected.

7. START CORE TEMP MODE COOKING.



Press 'Timer-Start/Stop' key to start Core Temp Mode cooking. 'Timer-Start/Stop' LED is 'On' during Core Temp Mode cooking. Lower Display will alternately flash between 'CP' and Core Probe Set Temperature during cooking.

8. CANCELLING CORE TEMP ALARM (CORE TEMP SETTING REACHED - COOKING COMPLETE).

When Core Probe Set Temperature is reached, an alarm will sound and the Lower Display will flash. Fan and heating are paused.



- Press 'Timer-Start/Stop' key to cancel alarm, oven will resume cooking at Oven Set Temperature. Displays will show Oven Set Temperature and Core Probe Set Temperature.

- Alternatively, open oven door to cancel alarm. Close oven door to resume cooking at Oven Set Temperature. The displays will revert to the Oven and Core Probe Set Temperatures.

NOTE: Any of the above settings can be adjusted during cooking operation by using the above controls and keys.



• **Viewing Actual Oven and Core Temperatures.** During cooking, press 'Temp' key to view Actual Oven Temperature (Upper Display) and Actual Core Probe Temperature (Lower Display). Actual temperatures will display for 5 seconds before display reverts to show Oven Set Temperature (Upper Display) and Core Probe Set Temp (Lower Display).

• Exiting Core Temp Cooking Mode. Disconnect Core Probe from connector on lower right side of control panel. Lower Display and 'Timer' knob will revert to normal Timer Mode operation.

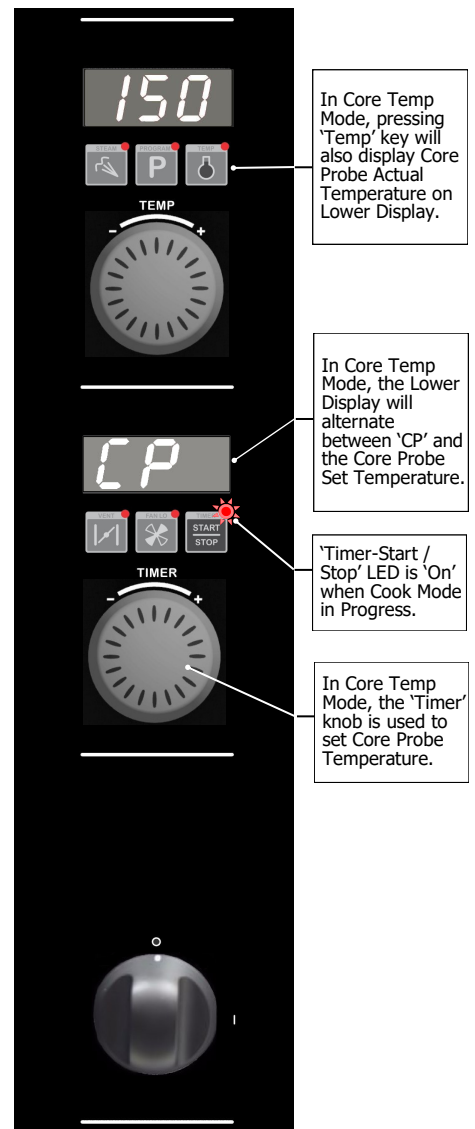

In Core Temp Mode, pressing 'Temp' key will also display Core Probe Actual Temperature on Lower Display.

In Core Temp Mode, the Lower Display will alternate between 'CP' and the Core Probe Set Temperature.

'Timer-Start / Stop' LED is 'On' when Cook Mode in Progress.

In Core Temp Mode, the 'Timer' knob is used to set Core Probe Temperature.

Operation

Baking in Program Mode

The oven can be pre-programmed with up to 30 Programs; each program can contain a maximum of 3 stages. When you receive your oven, the controller is not pre-programmed.

1. SELECTING A PROGRAM.



Press 'Program' key.

Upper Display will show program number selected.



+ to scroll forward through programs.
- to scroll backward through programs.

Lower Display will show **PrH**, oven is 'Pre-Heating'.
Program cannot be started until pre-heating is completed.

- If Lower Display is blank, the vent will be opening or closing to match the program.

2. OVEN READY.

Lower Display will show **rdy** when oven is up to pre-heat temperature and an alarm will sound.

Load product into oven.

3. CONNECT CORE TEMP PROBE (IF REQUIRED).

Connect Core Temp Probe to connector on lower right side of control panel, **CP** will be displayed on Lower Display.

NOTE: A Core Temp Probe can be used as part of a multi-stage cooking program. If a program reaches a Stage that requires a Core Temp Probe and no Core Temp Probe is connected, an error alarm will sound and 'CP' will flash on Lower Display. The program is automatically paused until the Core Temp Probe is connected. Once the probe is connected to the control panel and inserted into the food product, press the 'Timer-Start / Stop' key to resume the program.

4. START PROGRAM.



Press 'Timer-Start/Stop' key to start baking program.

Pressing and holding 'Timer-Start / Stop' key for 3 seconds will cancel the program and return to the Preset Program.

During Program Operation the Upper and Lower Displays will show the following:-

- Upper Display shows Program Number, e.g. **P01**
- Lower Display will show either,
 - Total Time Remaining in Program.
- OR
- Total Elapsed Time of Program (if any Program Stages are set to CP or InF).
- OR
- Alternate between 'CP' and Core Probe Set Temp (if presently in a Core Probe Stage).

5. CANCELLING PROGRAM 'TIME UP' ALARM (BAKING TIME COMPLETED).

When program is completed, the alarm will sound.



- To cancel alarm, press 'Timer-Start/Stop', oven will continue to cook at Oven Set Temperature. Display will revert to Program Number (Upper Display) and Total Program Time (Lower Display).
- Alternatively, open oven door to cancel alarm and turn 'Off' fan and heating. Close oven door to resume baking at Oven Set Temperature. Display will revert to Program Number (Upper Display) and 'PrH' or 'Rdy' (Lower Display).



Operation

ADDITIONAL ADJUSTMENTS (These can be adjusted whilst Program Mode is running).

NOTE: Adjustments made during baking will not be saved to the program.

A. VIEWING STAGE NUMBER AND STAGE TIME REMAINING.

To view the Program and Stage numbers on the Upper Display, e.g. 3.1 = Program 3, Stage 1, and the Total Time Remaining in Stage remaining on the Lower Display:

- Press 'P' key during Program Baking.

OR

- Turn Timer knob in either direction.

- Upper Display will show Program and Stage, e.g. 

- Lower Display will show either,
 - Total Time Remaining in Stage.

OR

- Total Elapsed Time of Stage (if Stage is set to 'InF').

OR

- Core Probe Set Temp (if Stage is set to 'CP').

OR

- Alternate between 'CP' and Core Probe Set Temp (if presently in a Core Probe Stage).

Display will revert back to Overall Display after 5 seconds.

B. USING 'TEMP' KNOB DURING PROGRAM BAKING.

• VIEWING SET TEMPERATURE

Turn 'Temp' knob (in either direction) to display Set Temperature of Current Stage on Upper Display. Display will revert back to Overall Display after a 5-second delay.



• ADJUSTING SET TEMPERATURE

Hold 'Temp' knob in either direction for 3 seconds will enter 'Temp Edit Mode' where 'Temp' knob can be used to temporarily adjust temperature for the current stage. Controller will update the Temperature and exit 'Temp Edit Mode' after a 5-second delay.

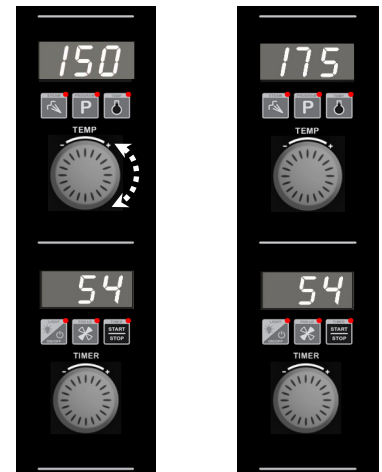

Oven Set Temperature has been increased from 150 to 175°C.

C. USING 'TIMER' KNOB DURING PROGRAM BAKING.

• VIEWING STAGE NUMBER AND REMAINING TIME

Turn 'Timer' knob (in either direction) to switch the display from Overall (Program, Total Time remaining) to Current Stage-in-Progress (Stage, Stage Time Remaining). Display will revert to Overall display after a 5-second delay.



• ADJUSTING REMAINING TIME / ADJUSTING CORE PROBE SET TEMP

Hold the 'Timer' knob in either direction for 3 seconds to enter 'Timer Edit Mode' where 'Timer' knob can be used for temporary adjustment of either:



- Stage Time remaining.
- OR
- Core Probe Set Temperature.

The controller will update the value and exit 'Timer Edit Mode' after a 5-second delay. Time remaining can be adjusted between 0-180 minutes, but cannot be set to 'InF' or 'CP'.

Core Probe Set Temp can be set between 50-90°C (122-194°F).

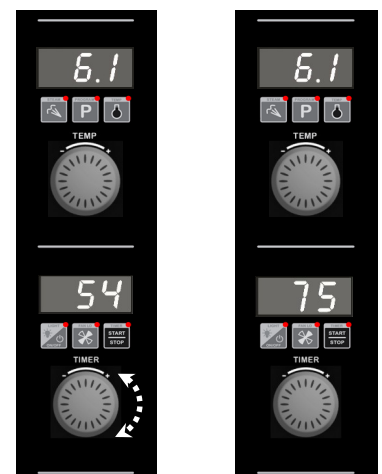

Here Core Probe Temperature has been increased from 54 to 75°C (129 - 167°F).

NOTE: Any changes will only apply to the current stage. Any following stages will revert to the programmed settings.

Operation

D. CHANGING THE STEAM TIME / MOISTURE SETTING.



Press and hold 'Steam' key for 3 seconds.
Rotate 'Temp' knob to select desired Steam Level (St0 to St9) / Moisture Level (H-0 to H-5).
Press 'Steam' key to confirm settings.

NOTE: Refer to 'Steam Mode / Moisture Mode Settings' at start of this section for additional explanation of steam / moisture level adjustments.

E. CHANGING FAN SPEED.



The pre-set fan speed can be changed by pressing 'Fan Lo' key. 'Fan Lo' indicator will illuminate when fan low speed is selected.

F. OPENING / CLOSING OVEN VENT.



Press 'VENT' key to open / close vent.
LED will flash whilst vent is moving and will illuminate when vent is open.

G. VIEWING ACTUAL OVEN TEMPERATURE / ACTUAL CORE PROBE TEMPERATURE.



Press 'Temp' key during cooking. Oven Set Temperature will display on Upper Display for 2 seconds, then Actual Temperature will display on Upper Display for 2 seconds. At the same time, Actual Core Probe temperature will display on Lower Display for 4 seconds. After 4 seconds, controller will revert to displaying the program number.

H. ADDING MORE TIME TO A STAGE WHEN THE END OF STAGE ALARM IS SOUNDING.

At the end of a stage, provided that 'ALr'=On, an end of stage alarm will sound for 1 minute before automatically progressing on to the next stage of the program. While alarm is sounding, additional baking time can be added to the stage that has just finished.



Rotate and hold 'Timer' knob for 3 seconds to enter Timer Edit Mode and add time to the stage.
When the length of time required has been added, either;



- Press 'Timer-Start/Stop' key to resume the stage,

OR

- Wait for the auto-resume feature to progress the oven on to the next stage, 1 minute after alarm initially sounded.



When the additional time has run out, the end of stage alarm will sound for a second time. Either press 'Timer-Start / Stop' key to progress on to the next stage, or let the program automatically progress on to the next stage after 1 minute of inactivity.

NOTE: Any changes will only apply to the current stage. Following stages will revert to the programmed settings.

Programming

Programming

The oven can be pre-programmed with up to 30 Programs; each program can contain a maximum of 3 stages. When you receive your oven, the controller is not pre-programmed. To set programs, carry out the following for each program required:



1. SELECT PROGRAMS MODE.

 Press 'Program' key to enter Programs Mode. 'Program' LED will illuminate.

2. SELECT PROGRAM REQUIRED (P01 - 30).

 Rotate 'Temp' knob to the program required. Upper Display will show program selected.

3. ENTER PROGRAMMING MODE.

 Press and hold 'Program' key until a beep is heard, indicating entry into Programming Mode. Upper Display shows program and stage numbers eg. = Program 3, Stage 1. 

'Program' LED will flash whilst in Programming Mode.

4. SELECT STAGE TO PROGRAM.

NOTE: If Multi-Stage Baking is disabled, (Parameter 'StG' - refer to section 'Controller Operator Settings') skip to Step 6 to continue programming otherwise continue as below and overleaf.

 All active stages and the first inactive stage are visible and can be accessed by rotating the 'Temp' knob to scroll through the stages. When editing a program for the first time, only the first stage will be visible and it will be 'Off' by default. Setting parameters for a stage changes its state from 'Off' to 'On' (activates the stage).

• To Turn a Stage 'On'.

 **Either** - Rotate 'Timer' knob clockwise to select 'On'.

 **Or** - Press 'P' key and program stage settings. (Setting all parameters for a stage automatically changes its state to 'On').

• To Turn a Stage 'Off'.

 Rotate 'Timer' knob anti-clockwise to select 'Off'.

NOTE: Only the last active ('On') stage can be turned 'Off'.

 Rotate 'Temp' knob:-
 '+' to advance one stage.
 '-' to go to the previous stage.

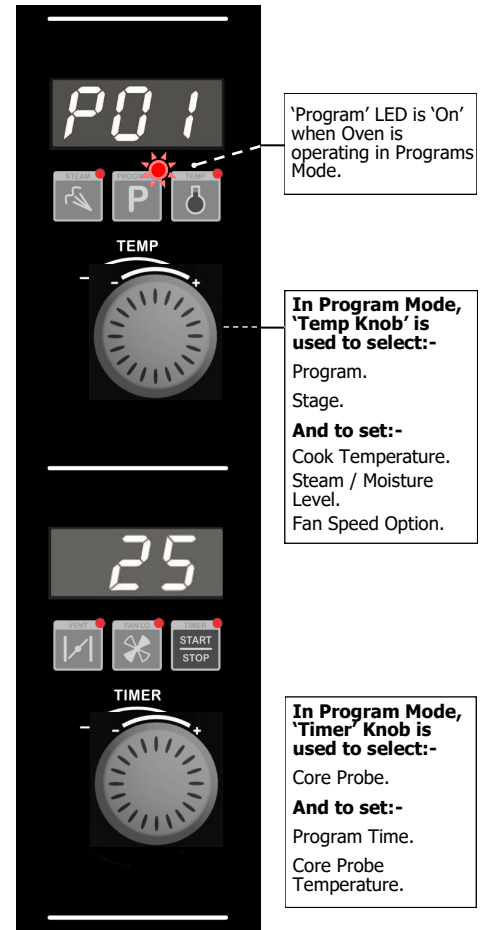

Program 3, Stage 1.
STATE: ON.

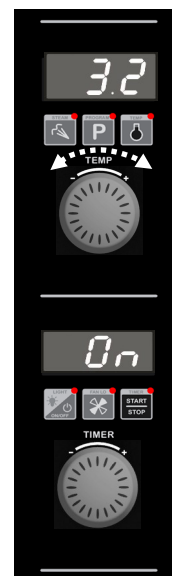

Program 3, Stage 2.
STATE: ON.

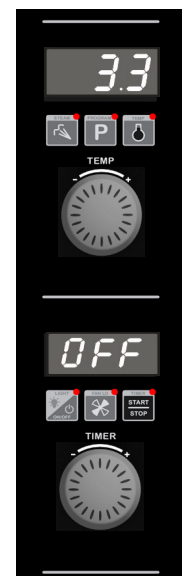

Program 3, Stage 3.
STATE: OFF (ie; Inactive).

Programming

5. CONFIRM STAGE TO EDIT.



Press 'Program' key to begin editing a program and stage displayed on the Upper Display.

6. SET OVEN TEMPERATURE.

Upper Display flashing



Rotate 'Temp' knob to select temperature required.

+ to increase the temperature (Max. 260°C / 500°F).
- to decrease the temperature (Min. 60°C / 140°F).



Press 'P' key to confirm temperature setting. Controller will step to Cook Time / Core Temp Probe setting.

7. SET COOK TIME / CORE TEMP PROBE.

Lower Display flashing

The 'Timer' knob can be used to select Core Temp Probe or a Cook Time option.

CP ← InF ← --- ⇒ 1 Min ⇒ 180 Mins

Turn and Release Timer Knob to change selection.

Turn and Hold Timer Knob to Fast Forward Fast Reverse.



--- = Stage has been set to 'OFF'.
InF = Infinity Time Setting.
CP = Core Temp Probe (optional extra).
Time = From 1 minute to 180 minutes.

- **By setting a Bake Time**, the stage will be governed by Oven Temperature, Steam Time (or Moisture setting) and Fan Speed and Vent setting.



Rotate 'Timer' knob to select time required.

+ to increase Cook Time (Max. 180 minutes).
- to decrease Cook Time (Min. 1 minute).



Press 'P' key to confirm Timer setting and advance to setting Moisture setting.

- **By setting Core Temp Probe (CP)**, the stage will run at a set Oven Temperature, Moisture Mode and Fan Speed until the actual core temperature reaches the pre-set core probe temperature value. Refer to the 'Cooking in Manual Mode with Core Probe' Section for instructions on cooking with the Core Probe fitted. Turn and hold timer knob until lower display shows 'CP'. Controller will step to setting Core Probe Temperature. Core Probe Temperature value is displayed on Lower Display.



Rotate 'Timer' knob to select temperature required.

'+' to increase Core Probe Temperature (Max 90°C / 194°F).
'-' to decrease Core Probe Temperature. (Min 50°C / 122°F).



Press 'P' key to confirm Core Probe Temp Setting. Controller will step to Moisture setting.

- **By setting Infinite Time setting ('InF')**, Oven counts time upwards up to a limit of 999 minutes. The Infinite ('InF') timer option is only available as an option when setting the last stage of a program. If the 'InF' timer option is programmed, no stages after the 'InF' stage will be available / visible. Turn 'Off' all stages that come after a given stage in order to set an 'InF' timer for that stage.



Press 'P' key to confirm infinite time 'InF' setting and advance to setting Moisture setting.

Programming

8. SET BAKE STEAM (St0 - St9) / MOISTURE (H-0 - H-5) OPTION.

Upper Display flashing



Rotate 'Temp' knob to select Steam setting required.

'+' to increase steam / moisture setting.
'-' to decrease steam / moisture setting.

(Refer to the start of the Operation section, 'Steam' / 'Moisture Mode Optional Settings', for additional explanation of moisture level adjustment).



Press 'P' key to confirm Steam setting. Controller will step to Fan Speed setting.

9. SET FAN SPEED (LO - HI).

Upper Display shows **FAN**

Lower Display Flashing with current Fan setting



Rotate 'Timer' knob to select desired fan option, shown on Lower Display.



Press 'P' key to confirm fan speed setting. Controller will step to Alarm setting for End of Stage.

NOTE: If Multi-Stage Baking is disabled, (Operator setting 'StG' - set to 'no'), the controller will exit the Programming Mode after the 'P' key is pressed to confirm fan speed setting.

10. SET VENT OPEN / CLOSED.



Set either 'VENT OPEN' or 'VENT CLOSED' as required for this baking stage.

11. SET ALARM FOR END OF STAGE ('ON-OFF').

Upper Display shows **ALR**

Lower Display flashing with current alarm setting



Rotate 'Timer' knob to select desired alarm state which will be shown on the Lower Display.

'ON' - Alarm sounds at completion of the baking stage, the program is paused awaiting user action. Without any input, the program will automatically resume after 1 minute.



- Press 'Timer-Start/Stop' key to stop the alarm, resume baking and to continue to the next baking stage.

OR



- Open oven door to stop alarm. Close door and press 'Timer-Start / Stop' key to continue baking and to continue on to the next baking stage.

'OFF' - Oven continues on to the next baking stage without sounding an alarm.

NOTE: Regardless of the setting applied to the last stage of the program, a Cook Time Completed Alarm will sound to indicate the end of the program.



Press 'P' key to confirm alarm option. Alarm will sound to confirm that all stage parameters have been set.

Repeat Step 1 to Step 11 to program additional stages.

12. EXIT PROGRAMMING MODE.



Press and hold 'P' key for 3 seconds until alarm sounds to exit the Programming Mode.

USB Export / Import

USB Export / Import - Programs

The Oven controller is equipped with USB connectivity, through the USB port located on the lower right hand side of the control panel.

The set of programs, **P01 - P30**, stored in the controller memory can be:

- Written to a USB memory stick (Export).
- Replaced with a set of programs located on the USB stick (Import).

1. To export the set of programs from the controller to the USB stick:

- Ensure the oven is in 'Standby Mode' – 'On / Off' LED is lit.
- Insert a USB memory stick into the USB port.
- Upper display will show 'USB' and lower display will show 'EPr' (Export Programs).
- Press 'Start / Stop' button.
- Lower display will alternate between 'rEv' and '001' (Revision Number e.g. 000 to 999). (The set of programs can be given a different/new revision number at this point)
- Rotate 'Timer' Knob to select revision number required.
- Press 'Start / Stop' button to copy programs from controller to USB stick. If an error message (Err, Er1 or Er2) appears in lower display, refer to section 'Fault Finding'
- Lower display will show 'rUn', followed by 'dnE' once copying is done.
- Remove USB memory stick from USB port.
- Controller will go back to 'Standby Mode'.

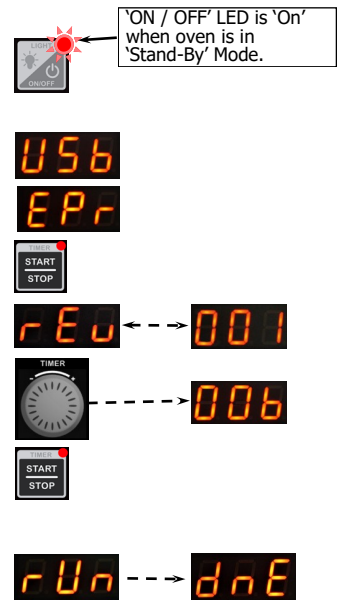

The export feature is useful for backing up the set of programs created in the controller, creating a copy of the set of programs to apply to another oven, and for editing programs externally.

2. To import the set of programs to the controller from the USB stick:

- Ensure the oven is in 'Standby Mode' - 'On / Off' LED is lit.
- Insert a USB memory stick, containing at least one 'MPRGRXXX.csv' file into the USB port (See Section 'Import / Export Files').
- Upper display will show 'USB' and lower display will show 'EPr' (Export Programs).
- Rotate 'Timer' knob to change to 'IPr' on lower display (Import Programs). **NOTE: IPr will not show on display if a 'MPRGRXXX.csv' file is not present.**
- Press 'Start / Stop' button to copy programs from USB stick to controller.
- If more than **one** file is present, i.e. MPRGR001, MPRGR002..., the option to select between these will appear:
- Lower display will alternate between 'rEv' and '001' (Revision Number e.g. 000 to 999).
- Rotate 'Timer' Knob to select revision number required. (A maximum of **10 revisions** on the USB Stick will be selectable).
- Lower display will show 'rUn', followed by 'dnE' once copying is done.
- Remove USB memory stick from USB port
- Controller will go back to 'Standby Mode'.

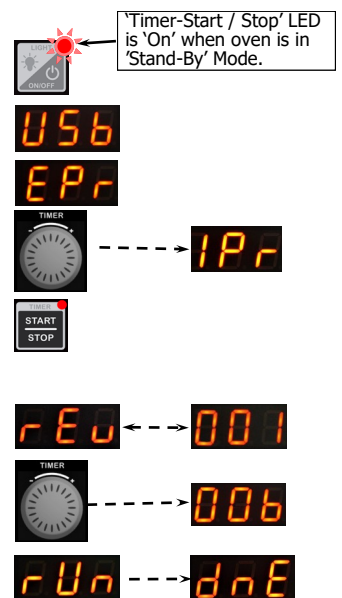

The import feature is useful for restoring a backed up set of programs, copying programs from another oven, and for loading programs edited externally.

USB Export / Import

USB Export / Import - Parameters

With the USB connectivity, it is also possible to export / import the parameters that determine the functions of the oven. The export function described under '**USB EXPORT / IMPORT – PROGRAMS**', also exports the parameter file '**PARAM.csv**', so the process is almost identical:

1. To export the Parameters from the controller to the USB stick:

- Ensure the oven is in '**Standby Mode**' - '**On / Off**' LED is lit.
- Insert a USB memory stick into the USB port.
- Upper display will show '**USB**' and lower display will show '**EPr**' (Export Programs).
- Press '**Start / Stop**' button to copy programs from controller to USB stick.
- Lower display will show '**rUn**', followed by '**dnE**' once copying is done.
- Remove USB memory stick from USB port.
- Controller will go back to '**Standby Mode**'.

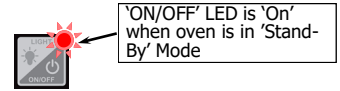

The export feature is useful for backing up the parameters in the controller, or creating a copy of the set of parameters to apply to another oven.



2. To import the set of parameters from the USB stick to the controller:

- Ensure the oven is in '**Standby Mode**' - '**On/Off**' LED is lit.
- Insert a USB memory stick, containing a '**PARAM.csv**' file, into the USB port (see Section '**Import / Export - Files**').
- Upper display will show '**USB**' and lower display will show '**EPr**' (Export Programs).

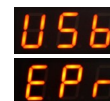
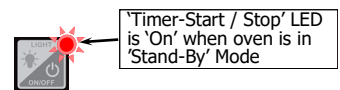

Important:

If a set of programs, '**MPRGRXXX.csv**'-file, is also present on the USB stick, this will be imported as well, **overwriting** existing programs in oven controller.

Make sure to only have the intended file(s) present on the USB Stick !

- Rotate '**Timer**' knob to change to '**IPr**' on lower display (Import Programs).
- Press '**Start/Stop**' button to copy parameters from USB stick to controller.
- Lower display will show '**rUn**', followed by '**dnE**' once copying is done.
- Remove USB memory stick from USB port.
- Controller will go back to '**Standby Mode**'.

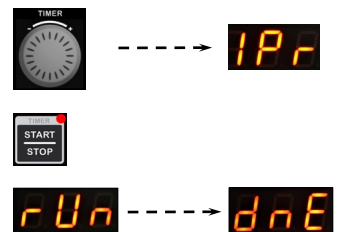

The import feature is useful for restoring a backed up set of parameters, or applying a copy of parameters from another oven.



USB Export / Import

USB Export / Import - Programs Revision Numbering

The 'Set of Programs', P01-P30, in the controller, has a revision number attached to it, for the purpose of keeping track of changes and updates to the set of programs stored in the controller or externally on USB Stick / PC.

1. To view the current Program Set Revision Number:

Enter into 'User Settings', as described under 'Controller - User Settings'.

Quick Guide:-

- Place the oven into 'Standby Mode' - 'On / Off' LED is lit.
- Press and hold 'Steam' and 'Start / Stop' buttons together until 'PAS' is showing in upper display.
- Rotate 'Timer' knob until '123' shows on lower display.
- Press 'FAN LO' button.
- Rotate 'Timer' knob until parameter 'PrG' shows in upper display.
- Lower display will alternate between showing 'rEu', (for revision), and the revision number, i.e. '001'.
- The revision number can be edited, if required, in the same manner as other 'User Settings'.
(Refer to 'Controller - User Settings' on the following pages)

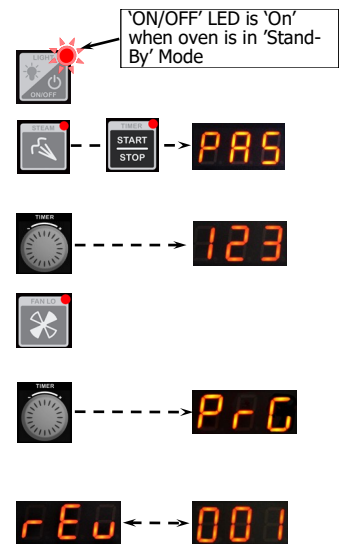

Refer section 'USB Export / Import - Programs' for further information on using 'Programs Revision Numbering'.

USB Export / Import

USB Export / Import - Files

The files, used for the export / import of the sets of programs and parameters, are separate files:

Set of Programs: MPRGRXXX.csv. (Where XXX is revision number 000-999)

Parameters: PARAM.csv.

Important:

Existing files with these names, on the USB stick, will be overwritten and not retrievable from the USB stick, unless the file(s) is 'read only'.

Attempting to export to a 'Read only' file name will result in an error message (Er1 or Er2) - See section 'Fault Finding' for further details.

With the export command, both files are copied to the USB stick.

It is recommended that a backup copy of the file(s) is kept in a separate storage location and the revision numbering option is used, i.e 'MPRGR001.csv'. ??

Refer to Section '**Program Set Revision Numbering**'.

With the import command, both the selected programs file and the parameter file are loaded into the controller, if present on the USB stick.

Important:

Make sure only the intended file is present on the USB stick, if transferring only Programs or only Parameters.

If only programs file(s), MPRGRXXX.csv or Parameter file PARAM.csv, is present on the USB stick, that file alone will be loaded into the controller.

Controller - Operator Settings

Changing Operator Settings

With the Oven in 'Stand-By' Mode (i.e. Power to oven but both displays are blank).

1. ENTERING THE OPERATOR SETTING MODE.



Press and hold 'Steam' and 'Timer-Start/Stop' keys together for 3 seconds.

Upper Display will show **PAS**.

Lower Display will flash **000**.

2. SETTING PASSWORD (OPERATOR PASSWORD - 123).



Rotate 'Timer' knob to set password **123**.



Press 'Fan Lo' key to confirm password.

Upper Display will show one of the setting codes, eg. **P-H**

Lower Display will show the value of the setting, eg. **185**

3. CHANGING THE OPERATOR SETTINGS.



Rotate 'Timer' knob to the setting required.



Press 'Fan Lo' key to confirm setting required. Lower Display will flash.

While Lower Display is flashing, rotate 'Timer' knob to select value required.



Press 'Fan Lo' key to confirm value. Lower Display will stop flashing.

4. EXITING THE OPERATOR SETTING MODE.



Press 'Vent' key, to return to Stand-By Mode.

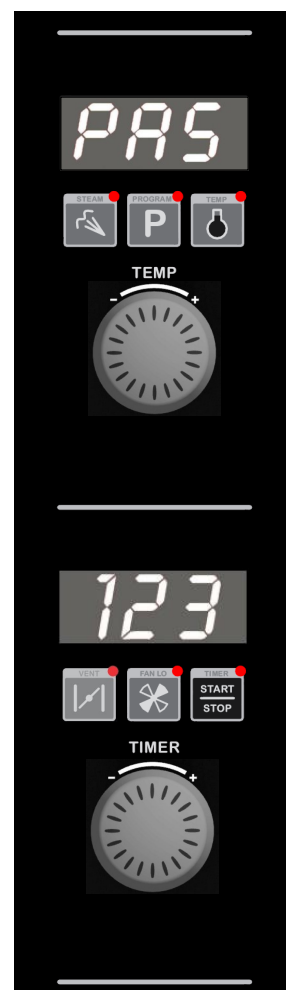

Operator Settings

Setting No	Description	Range	Default
P-H	Oven Pre-Heat; - (Automatic Pre-Heat Temp on oven start-up).	60 - 260°C 140 - 500°F.	150°C (325°F)
L-0	Light Auto 'Off' Setting Time - 0 = 'On/Off'. 1 = 1 minute auto 'Off'. 2 = 2 minutes auto 'Off', etc.	0 - 60 mins.	2
Est	Enable Bake Steam / Moisture Mode 0 = Steam disabled. 1 = Bake Steam Mode - provides a timed steam injection at start of bake cycle. 2 = Moisture Mode - provides regular moisture injection throughout cook cycle.	0 - 2	1
uol	Alarm Volume - Can be adjusted to suit operators preference.	0 - 10.	5
P-E	Program Pre-Heating Condition - This setting allows for pre-heating 'Ready' temperature in 'Program Mode' Mode to be set higher than Program Set Temperature. Factory Default Setting is '0' (Equal to Program Setting).	0 - 30°C 0 - 54°F.	0
StC	Multi-Stage Enable - This setting enables multi-stage programming. Factory default is 'YES', multi-stage programming is enabled. Setting this to 'no' simplifies programming and program baking.	'YES' or 'no'.	YES

Cleaning and Maintenance

Cleaning Guidelines



Caution

Always turn off electrical power at the mains supply before commencing cleaning.

This oven is not water proof. Do not use water jet spray to clean interior or exterior of the appliance.

To achieve the best results, cleaning must be regular and thorough. If any small faults occur, have them looked at promptly. Don't wait until they cause a complete breakdown.

NOTE:

- Carefully read and follow the safety instructions on the label of the cleaning product to be used.
- DO NOT use harsh abrasive scouring pads or abrasive detergents as they could damage the oven.
- Ensure that any detergent or cleaning material has been completely removed after each cleaning.

To keep your oven clean and operating at peak efficiency, follow the procedures shown below:-

Oven Cleaning

NOTE:

- If oven usage is very high, the cleaning procedure should be carried out more frequently.
- Allow the oven interior to cool to approx 50°C / 120°F before commencing cleaning.

Stainless Steel Surfaces

- Thoroughly clean the exterior surfaces of the oven with, a damp cloth moistened with a mild detergent solution, or a soft bristled brush.
- Baked on deposits or discoloration may require a good quality stainless steel cleaner. Always apply cleaner when the oven is cold and rub in the direction of the grain.

Oven Interior

- Remove the oven racks as shown overleaf.
- Clean any build up of grease from the oven interior, using a soft bristled brush with a solution of hot water and a mild anti bacterial detergent.
- Dry the oven thoroughly with a soft dry cloth.
- Clean the oven regularly with a good quality oven cleaner.

Door Seal

- To remove, pull out the seal starting at each corner.

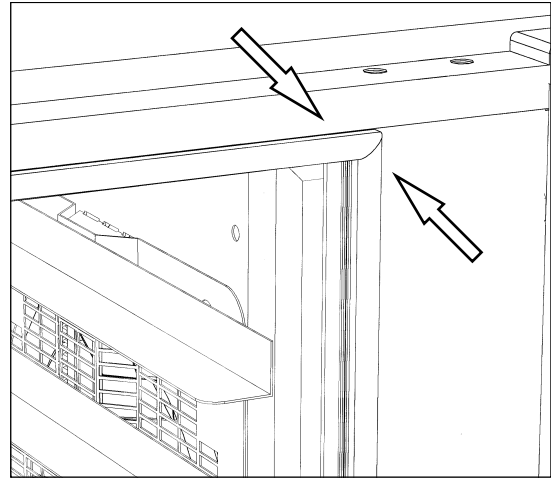

- The seal may be washed in the sink, but take care not to cut or damage it.
- Check the door seal for wear and damage and replace as required.
- Wash the door seal in a sink, taking care not to cut or damage the seal.
- Dry the door seal thoroughly.
- Refit the door seal with lip facing into centre of the oven.
- Press the door seal into the locating groove in the front face of the oven until the seal is properly located all around the oven.

Oven Door Glass

Outer Surfaces

Clean with conventional glass cleaners

Inner Surfaces

- To clean between the inner and outer door glasses, firstly ensure the oven door is locked shut.
- With a screwdriver, coin, or other suitable device, ¼ turn the outer glass locks to release the outer glass and allow it to be hinged open for cleaning access (refer diagram for correct locking / unlocking procedure).

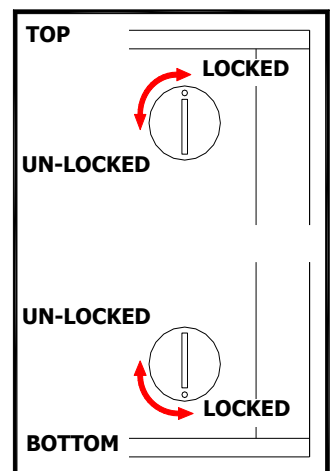

Cleaning and Maintenance

Side Racks - Removal

1. Lift the side rack off the bottom locating pins.
2. Move the bottom of the side rack toward the centre of the oven.
3. Lower side rack to clear top locating pins, and remove.

Side Racks - Re-Fitting

NOTE: The side racks can be fitted in one of two positions, in order to take 16 or 18 inch trays. Ensure that the racks are fitted correctly for the tray spacing required.

1. To position racks for 16 inch trays, use the holes at the rear of the rack.

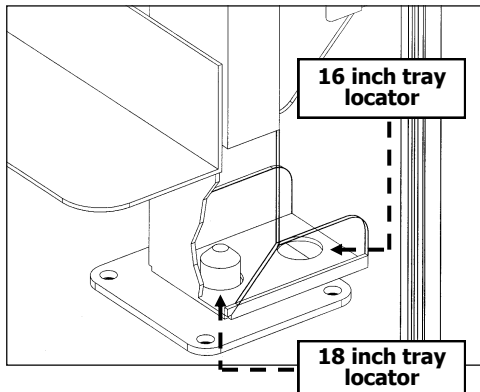

2. Alternatively for 18 inch trays, use the holes nearest the centre of the oven.

Re-fitting Racks to Oven

1. Insert rack into the oven, placing appropriate holes over the top locating pins.
2. Lift the side rack over the bottom locating pins.
3. Lower side rack with the appropriate holes over the bottom locating pins.

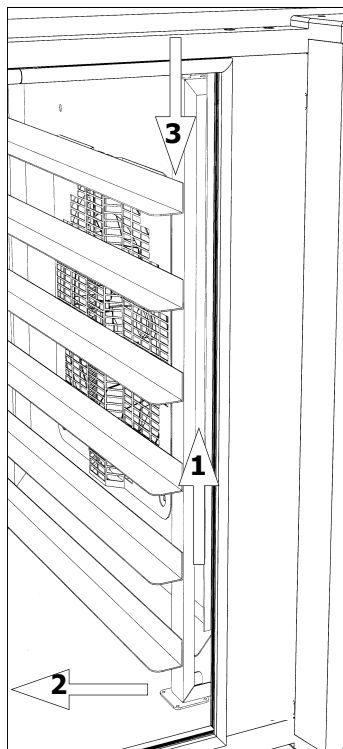

Oven Lamps

- a. Remove the LH side rack as shown previously.



- b. Wash the glass lens with a soft sponge using warm water and a detergent solution. Rinse with clean, warm water.



- c. Dry the glass lens thoroughly with a dry cloth.
- d. Refit LH side rack as shown previously.

Periodic Maintenance

NOTE: All maintenance operations should only be carried out by a qualified service person.

Controls and mechanical parts should be checked and adjusted periodically by a qualified service person. It is recommended that the appliance is serviced every 6 months.

Fault Finding

This section provides a reference to the more common problems that may occur during the operation of your oven. This fault finding guide is intended to help you correct and accurately diagnose problems with your oven.

You may encounter a problem not covered in this section, please contact your service provider who will require the following information:-

When fault finding a problem, always use a process of elimination starting with the simplest solution and working through to the most complex. Never overlook the obvious.

- **The Model and Serial Number of the oven, can be found on the Technical Data Plate located on the front right hand side panel of the oven.**

Fault	Possible Causes	Remedy
Oven does not operate.	Mains isolating switch, circuit breaker or fuses are Off at the power board. Overtemp tripped (No lights, no power light). Overtemp faulty. Digital Controller faulty Element faulty.	Turn On. Call for service. Call for service. Call for service. Call for service.
Oven Controller operates but No Heat in Oven.	Digital Controller faulty Door not closed fully (display shows ' dor '). Door Switch faulty (display shows ' dor '). Heating Contactor faulty.	Refer to 'Digital Controller Fault Codes'. Call for service. Close door. (Refer 'Door does not close fully'). Call for service. Call for service.
Oven heats up but Fan does not operate.	Fan motor faulty. Fan or fan motor obstructed. Controller faulty. Fan Contactor faulty. Fan Capacitor faulty.	Call for service. Call for service. Call for service. Call for service. Call for service.
Oven does not produce moisture.	Moisture Mode not selected. Injector Nozzle blocked. Water Solenoid faulty. Controller faulty.	Check Moisture Mode settings. Call for service. Call for service. Call for service.
Door does not close fully.	Tray in way of door (display shows ' dor '). Door misaligned (display shows ' dor '). Door seal obstruction (display shows ' dor ').	Correctly position tray in rack. Re-align door. Correctly install door seal. (Refer to 'Cleaning' Section).
Oven light not illuminating.	Blown bulb (one bulb not working). Blown fuse (both bulbs not working).	Call for service. Call for service.
Uneven baking.	Too high a temperature selected. Oven or racks not level. Insufficient air space around trays or baking tins. Oven overloaded with too much product. Opening oven door un-necessarily. Oven door seal damaged or faulty. Oven vent restricted.	Select a lower temperature. Check oven racks and level. Ensure oven racks are spaced to allow air flow around baking on all shelves. Re-load oven. Ensure oven door is closed during baking. Check seals and replace if damaged. Ensure oven vent not blocked or shrouded.
Control Panel does not indicate 'CP' when Core Probe connected.	Core Probe Faulty	Replace Core Probe.
'Err 001' on display. 'Err 002' on display. 'Err 003' on display.	Oven Probe failure. PT2 Core Probe input error. Motor Thermal Cut-Out tripped.	Call for service. Probe short circuit. Call for service. Call for service.
'CP' flashing on Lower Display, alarm sounding, oven program paused.	Core Probe not connected to control panel, and program requires its use. Core Probe Faulty.	Connect Core Probe to control panel. Replace Core Probe.
'Err Hod' on display, or VH Hood installed, but not running correctly.	VH Hood not plugged in or not switched ON. Oven controller programmed incorrectly. Oven controller, wiring or VH hood faulty.	Ensure VH Hood is plugged in & switched ON. Call for service. Call for service.

Electrical Schematics

Electrical Schematic E35D6 Turbofan Oven. 1 Phase (1P+N+E) 208-240V Models

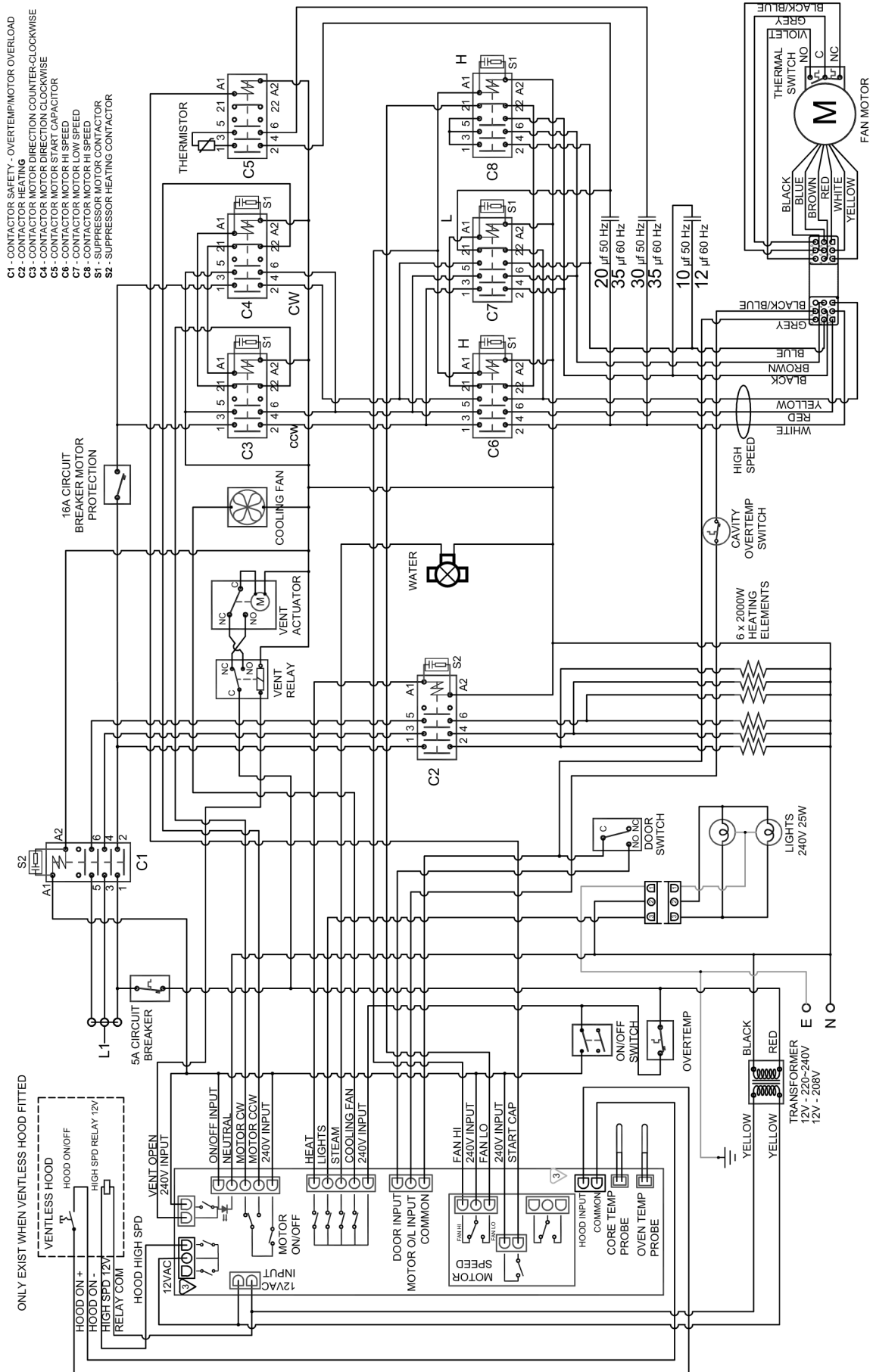

Electrical Schematics

Electrical Schematic E35D6 Turbofan Oven. 3 Phase (3P+Gnd) 208-240V Models

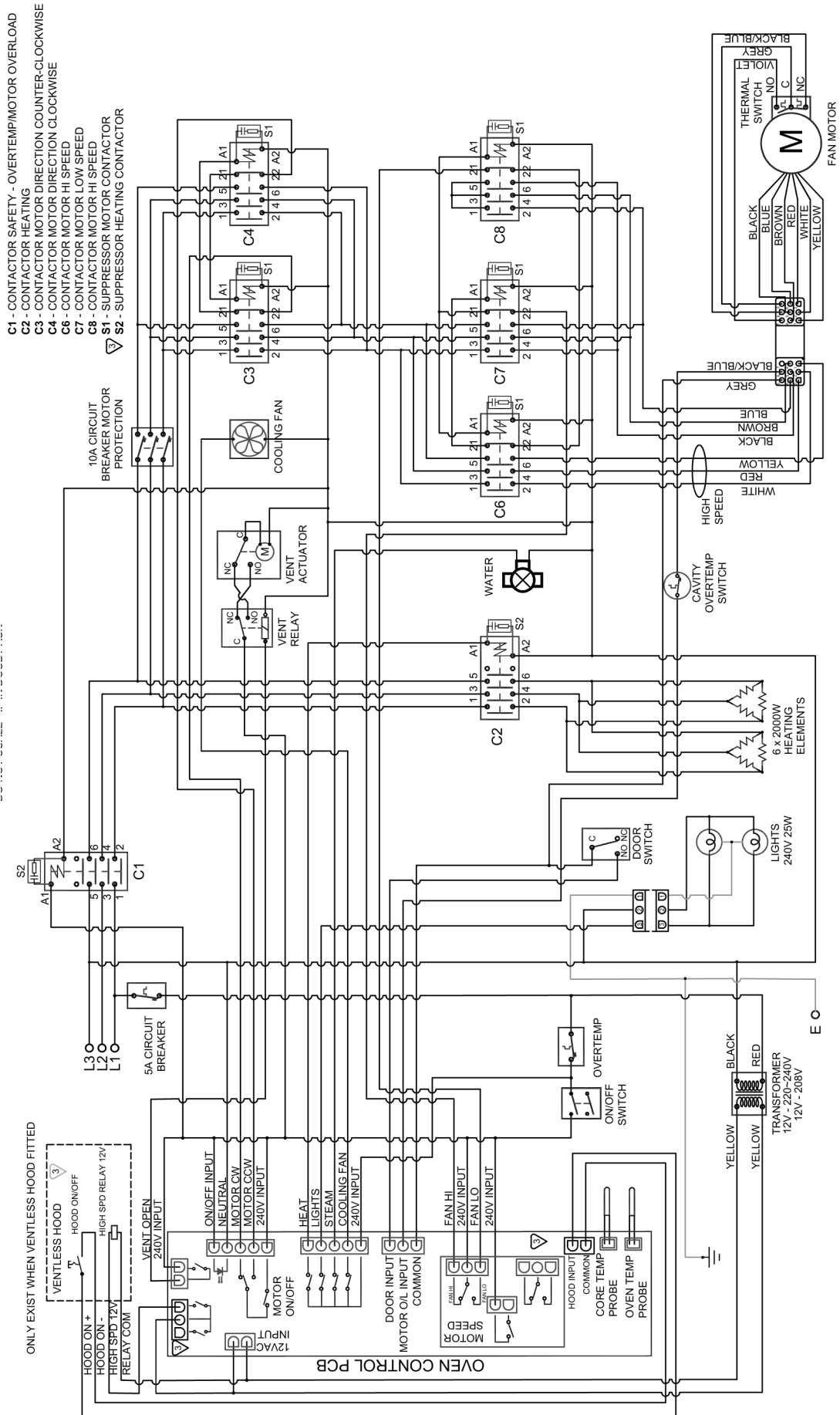

Electrical Schematics

Electrical Schematic E35D6 Turbofan Oven. 3 Phase (3P+N+E) 380-415V Models

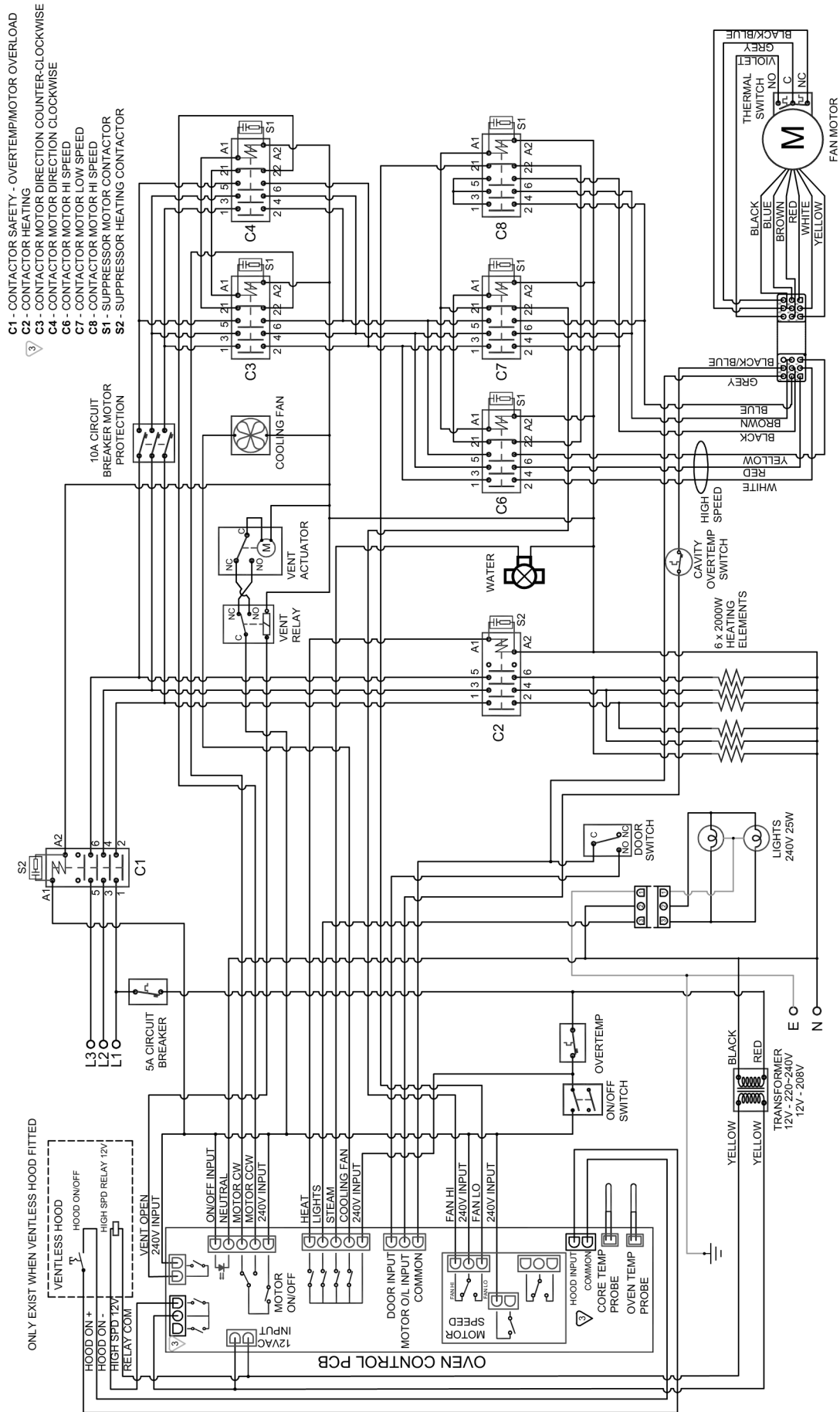

Replacement Parts List

Important:

**Only genuine authorized replacement parts should be used for the servicing and repair of this oven. The instructions supplied with the parts should be followed when replacing components.
For further information and servicing instructions, contact your nearest authorized service provider or Turbofan Dealer.**

When ordering replacement parts, please quote the part number and the description as listed below. If the part required is not listed below, request the part by description and quote model number and serial number which is shown on the Technical Data Plate.

Part No.	Description
246972	Control Panel Laminated E35D USB
247184	Digital Controller Kit 30D USB-series.
243260	Rotary Encoder and Cable.
243261	Rotary Control Knob.
235700	USB Cable.
020822	Selector Switch - Power
234447	Power Knob
237447K	Temp Probe 20mm PT1000
240109	Thermistor 10ohm (Single Phase Models Only)
231746	Suppressor Heating Contactor
231747	Suppressor Motor Contactor
231739	Contacto BF1810A230 (Heating / Safety, 1 Phase / 3 Phase +N+E)
231743	Contacto Interlock 11BGX5000
231742	Contacto NC 11BG0601A230 (Mini Contactor - Motor Switching)
231740	Contacto BF3200A230 (Heating / Safety, 3 Phase+E)
021534	Relay 240V LY1F
239834	Circuit Breaker 1P 5A W57
239833	Circuit Breaker 1P C 16A
305449	Circuit Breaker UL/CSA 10A 3P
025400	Overtemp Thermostat 360°C
239860	Cooling Fan 120 x 120 x 38 230Vac
240034	Thermal Switch 70°C
239581	Vent Actuator Motor
020763K	Element 2000W 220V (208/220/380V)
020762K	Element 2000W 240V (240/415V)
022259K	Element 1250W 220V (E358D - 400-415V, 50Hz, 3P+N+E, 8Kw Only)
240019	Motor L9EB50, 208-240V, 60Hz, 1P/3P (includes Shaft Seal)
240018	Motor L9EB50, 220-240V, 50Hz, 1P/3P (includes Shaft Seal)
240017	Motor L9EB40, 380-415V, 50Hz, 3P (includes Shaft Seal)
020896	Motor Shaft Seal
239317	Fan D350 x H80, 12 Blade
232551	Capacitor 10µF (230-240V, 50Hz, 1P+N+E)
232553	Capacitor 20µF (230-240V, 50Hz, 1P+N+E)
232554	Capacitor 30µF (230-240V, 50Hz, 1P+N+E)
232552	Capacitor 12µF (208V, 60Hz, 1P+N+E)
232555	Capacitor 35µF (208V, 60Hz, 1P+N+E)
231814	Lamp G9/25W 230V Halogen
232108	Lampholder G9 Halogen
021352	Glass Lens
021353	Support Frame
242092	Lamp Gasket
238981	Water Solenoid
020853	Whirl Jet Spray Body
020856	Water Tube Gasket
025922	Adaptor 3/4" BSP/GHT Brass (USA/Can/Mexico Only)
021527	Washer Rubber 23 x 14.5 x 1.5mm (USA/Can/Mexico Only)

Replacement Parts List

Part No.	Description
024802	Door Microswitch
235354	Door Switch Return Spring
017929	Damper Rod Clip
231438	Door Seal
236885	Gasket - Door Switch / Oven Temp Probe
239519	Door Inner Glass
239512	Door Outer Glass Assy
236198	Door Latch Cover
235859	Door Handle Assembly
231804	Single Step Locking Dog
232588	Door Outer Glass Locking Catch
232364	Door Outer Glass Locking Catch Spring
239527	Hinge Pivot Pin
239528	Hinge Pivot Nut

015168	Oven Rack (26" Only)
025916	Rack Runner LH WA 4T (26" Only)
025917	Rack Runner RH WA 4T (26" Only)
026127	Rack Runner LH WA 5T (26" Only)
026128	Rack Runner RH WA 5T (26" Only)
020809	Rack Runner LH WA 6T (26" Only)
020810	Rack Runner RH WA 6T (26" Only)
025089	Rack Runner LH WA 8T (26" Only)
025090	Rack Runner RH WA 8T (26" Only)

020993	Oven Rack (30" Only)
026590	Rack Runner LH WA 4T (30" Only)
026591	Rack Runner RH WA 4T (30" Only)
026789	Rack Runner LH WA 5T (30" Only)
026787	Rack Runner RH WA 5T (30" Only)
020811	Rack Runner LH WA 6T (30" Only)
020812	Rack Runner RH WA 6T (30" Only)
023018	Rack Runner LH WA 8T (30" Only)
023019	Rack Runner RH WA 8T (30" Only)

232379	Adjustable Leg 73-80mm (M10)
232380	O-Ring 4150

Optional Extras

Part No.	Description
236060	Core Temperature Probe Kit (which include)..
235845	<i>Core Temperature Probe (PT1000).</i>
235847	<i>Dust Cap - Core Temperature Socket.</i>
236271	<i>Core Temperature Probe Holder.</i>

Appendix 1 - Reversing the Oven Door

Reversing the Oven Door

Top Hinge Mount Plate Re-Positioning:

1. Isolate the oven from the mains power supply.
2. Close the oven door.
3. Remove the upper pivot pin and washer. **Take care to support the oven door.**
4. Carefully open door and lift door off bottom locating pin.
5. Undo and remove the two cap screws securing the top hinge mounting plate to the oven.
6. Remove the top hinge mounting plate and spacer.
7. Remove the blanking screws from the opposite side of the door opening and fit to where the hinge mount plate was removed from.
8. Turn the top hinge mounting plate over 180° and with the spacer, fit to the top RH side of the door opening and secure with the 2 cap screws and washers.

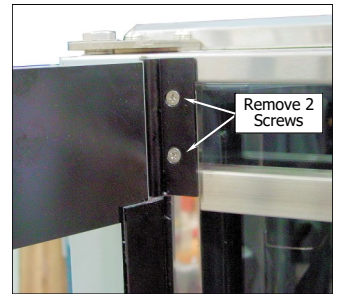
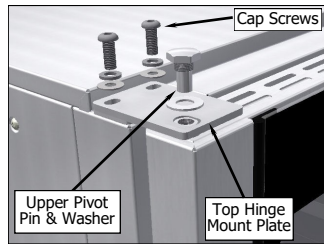

Bottom Bracket Re-Positioning:

1. Undo and remove the two hex screws securing the bottom bracket and remove the bracket complete with nut and washer.
2. Remove the pivot pin, washer and threaded insert, from the bottom bracket.
3. Fit the threaded insert, lower pivot pin and washer to the right hand hole in the bottom bracket.
4. Remove the blanking screws from the lower opposite side of the door opening and fit to where the bottom bracket was removed from.
5. Fit the bottom bracket to the other side of the door opening and secure with the hex screws.

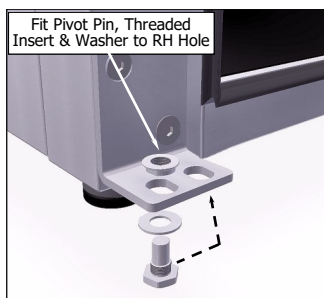
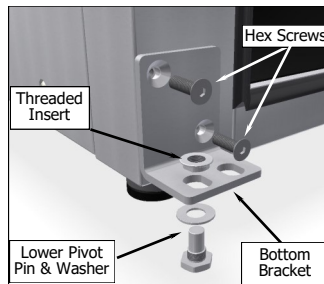

Door Outer Glass Reversal:

1. With the door removed from the oven, unlock and open the outer glass from the oven door to allow access to the outer glass hinges.

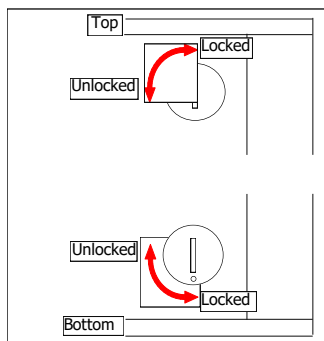

2. Remove the front glass from the oven door by removing the screws from the upper and lower hinges (two screws per hinge) and remove outer glass assembly.
3. Rotate the outer glass 180° and refit to the oven door. Ensure that the Turbofan Logo is at the bottom of the door
4. Secure the outer glass in the locked position.

Door Handle Reversal:

1. Remove the 2 screws from the door catch cover and remove the cover.



2. Remove 3 capscrews inside the handle recess.
3. Remove the door handle and turn the handle around 180° and refit to the door. Secure with the 3 capscrews.
4. Refit the door catch cover.

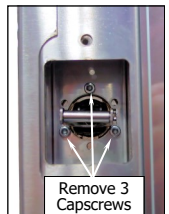

Door Locking Dog Re-Positioning:

1. Pull back the neoprene seal to reveal the Locking Dog securing nut.
2. Slacken the locking nut, unscrew the locking dog and remove locking dog, locking nut and neoprene seal.

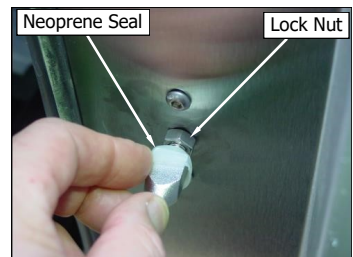

3. From the opposite side of the oven door frame, remove the centre cap screw and transfer to the old locking dog position.



NOTE: Do Not remove outer 2 Capscrews.

4. Fit the locking dog, nut and neoprene seal (removed at Item 2 above), to the opposite side of the door frame and once the door is fitted, adjust the locking dog as shown over the page.
5. Fit the door onto the lower pivot pin, align the top of the door with the top hinge mounting plate and secure with the upper pivot pin and washer.

NOTE: On completion of the door reversal operation, the door and door microswitch will require adjustment. Carry out the procedures shown overleaf to ensure that the door is correctly aligned and also seals correctly.

Appendix 1 - Reversing the Oven Door

Oven Door - Adjustment

Door Position Adjustment (Vertical Alignment):

1. To adjust the door vertical alignment, open oven door.
2. Loosen the screws securing the top door hinge plate to the oven.
3. Adjust oven door vertical alignment position and tighten the 2 cap screws.
4. Check door operation. Repeat steps 2 and 3 as necessary to ensure that door closes and latches evenly and is aligned in the door frame.

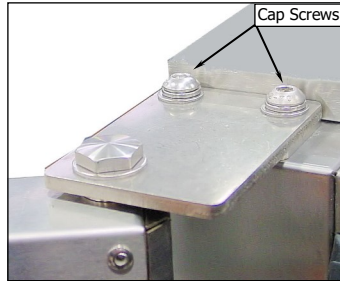

Door Seal Adjustment:

1. With the oven door closed and latched shut, loosen the upper hinge pin.
2. Lightly press the top of the door in the hinge area and tighten the upper hinge pin.
3. Repeat the adjustment for the lower hinge bracket.



Door Latch Adjustment:

1. Open the oven door to reveal the locking dog.
2. Pull back the neoprene seal to reveal the lock nut.
3. Slacken the lock nut.
4. Adjust the locking dog to the required position.
5. Slam the door shut and ensure that the door is not a loose fit when closed and that pressure is maintained against the door seal.
6. Continue to adjust the locking dog until the door shuts correctly.
7. Tighten up the lock nut and re-position the neoprene seal over the lock nut.

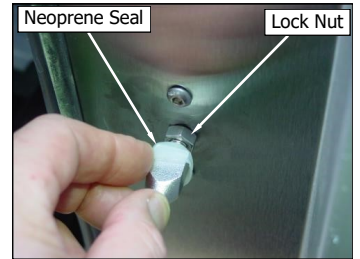

NOTE: Ensure that the Locking Dog is aligned with the hook facing downwards.



Microswitch Adjustment:

1. Open oven door.
2. Remove the control panel and bend the microswitch arm to adjust microswitch operation.
3. Open and close the oven door and check the microswitch operates correctly.

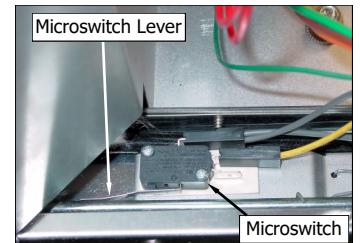

NOTE: The microswitch should operate when door handle is approximately $\frac{1}{2}$ engaged (45°).

4. Repeat Steps 2 and 3 as required, then refit the control panel.

