

Ventilation / Display Performance Considerations

- 1) Area in which display is to be sited must have a minimum room volume no less than 122 cu m.
- 2) Install over a sealed floor or ventilated floor void.
- 3) Do not site the display within 2m of ceiling mounted air conditioning grilles.
- 4) Do not site the display beneath a high level of direct sunlight.
- 5) Display will operate in a 24 hour environment.

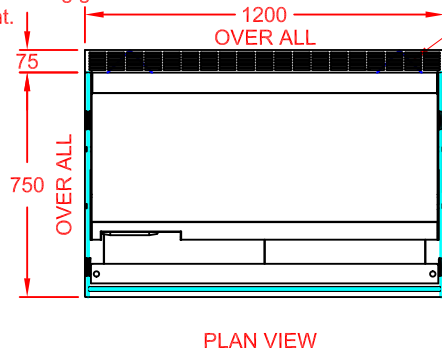

REMOVABLE AIR-OFF GRILLE AND WALL SPACERS FOR WALL SITED MODELS

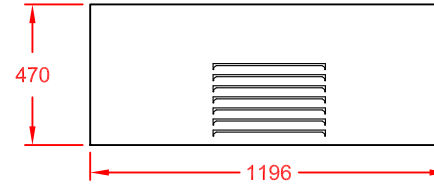

OPTIONAL FRONT FASCIA PANELS
KCBF12 - BLACK EPOXY COATED STEEL
KCSF12 - SATIN STAINLESS STEEL
FOR FREE STANDING MODELS

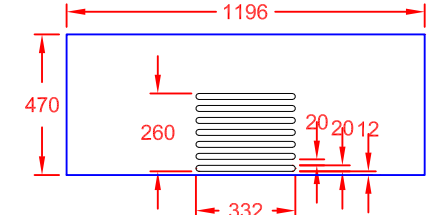

SUGGESTED REMOVABLE FASCIA PANEL & CUT OUT DETAIL (BY OTHERS)

GANTRY MOUNTED DIGITAL CONTROL PANEL

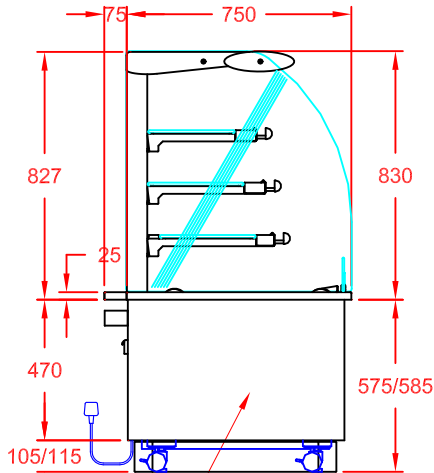

SIDE PANELS IN BLACK EPOXY COATED STEEL AS STANDARD OR OPTION KASB12 - SATIN STAINLESS STEEL PANELS

END VIEW

13A PLUG TOP & 2m LEAD POWER SUPPLY: 13A, 230V, 1.80kW

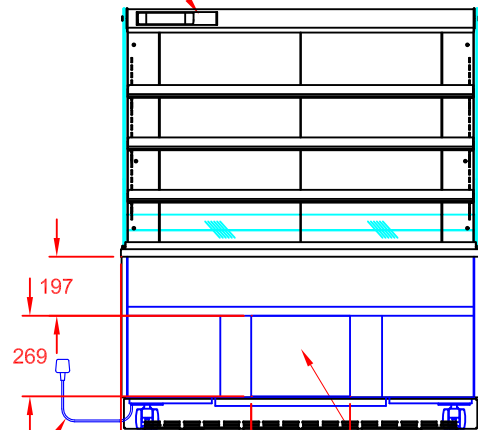

CUT-OUT LOCATION FOR AIR GRILLE IN FRONT FASCIA

FRONT VIEW (CUSTOMER SIDE)

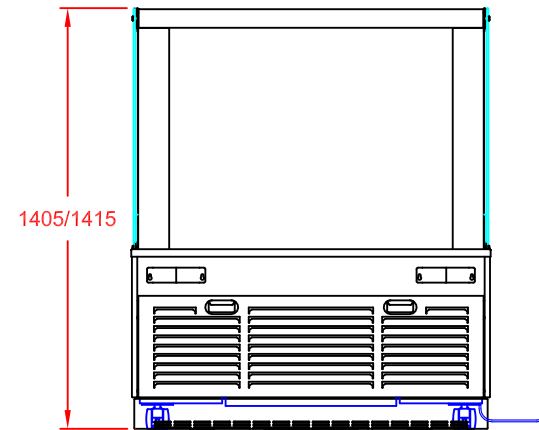

REAR VIEW (OPERATOR SIDE)

APPROX. UN-CRATED WEIGHT OF UNIT: 240Kg



CED FABRICATIONS LTD
UNITS A1-A4, FALCON COURT
CLAYTON BUSINESS PARK
CLAYTON-LE-MOORS
HYNDBURN
LANCASHIRE BB5 5JD

This drawing and information herein is confidential to CED Fabrications Ltd. It is issued in confidence that it will not be disclosed to any third party in part or in whole without permission from CED FABRICATIONS Ltd.

© CED FABRICATIONS LTD

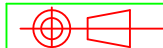

DESCRIPTION:

DESIGNLINE PATISSERIE
1200mm SELF HELP COLD - FIXED BACK
HYDROCARBON TYPE-R290 REFRIGERANT

SCALE: 1 : 25 @ A4

REV No: -

PRODUCT CODE:

PC12FBHT